

FEATURES

- **HIGH DENSITY SURFACE MOUNTING:**
6 Pin Super Minimold or SOT-363 package
- **HIGH GAIN:**
33 dB TYP
- **SATURATED OUTPUT POWER:**
+13.5 dBm
- **SUPPLY VOLTAGE:**
 $V_{CC} = 4.5$ to 5.5 V

DESCRIPTION

NEC's UPC2710TB is a Silicon RFIC manufactured using the NESAT III process. This device is suitable as a PA driver amplifier for cellular radio and other communication receivers. The UPC2710TB is pin compatible and has comparable performance to the larger UPC2710T, so it is suitable for use as a replacement to help reduce system size. The IC is housed in a 6 pin super minimold or SOT-363 package.

NEC's stringent quality assurance and test procedures ensure the highest reliability and performance.

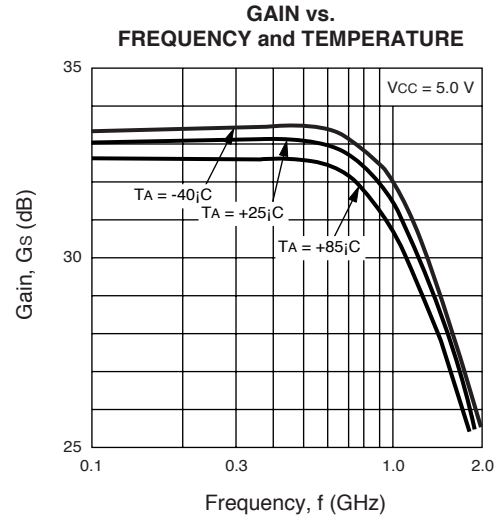

ELECTRICAL CHARACTERISTICS (TA = 25 °C, VCC = 5 V, f = 0.5 GHz)

PART NUMBER PACKAGE OUTLINE			UPC2710TB S06		
SYMBOLS	PARAMETERS AND CONDITIONS	UNITS	MIN	TYP	MAX
I _{CC}	Circuit Current (no signal)	mA	16	22	29
G _s	Small Signal Gain	dB	30	33	36.5
f _u	Upper Limit Operating Frequency (The gain at f _u is 3 dB down from the gain at 0.1 GHz)	GHz	0.7	1.0	
ΔG _s	Gain Flatness, f = 0.1 ~ 0.6 GHz f = 0.1 ~ 0.8 GHz	dB		±0.8	
P _{SAT}	Saturated Output Power	dBm	+11	+13.5	
P _{1dB}	Output Power at 1dB Compression Point	dBm		+7.5	
NF	Noise Figure	dB		3.5	5
RL _{IN}	Input Return Loss	dB	3	6	
RL _{OUT}	Output Return Loss	dB	9	12	
ISOL	Isolation	dB	34	39	
ΔGT	Gain -Temperature Coefficient	dB/°C		-0.006	
R _{TH}	Thermal Resistance (Junction to Ambient)	°C/W			325

UPC2710TB

ABSOLUTE MAXIMUM RATINGS¹ (T_A = 25°C)

SYMBOLS	PARAMETERS	UNITS	RATINGS
V _{CC}	Supply Voltage	V	6
P _{IN}	Input Power	dBm	+10
P _T	Power Dissipation ²	mW	200
T _{OP}	Operating Temperature	°C	-40 to +85
T _{STG}	Storage Temperature	°C	-55 to +150

Notes:

- Operation in excess of any one of these parameters may result in permanent damage.
- Mounted on 50 x 50 x 1.6 mm epoxy glass PWB (T_A = +85°C).

RECOMMENDED OPERATING CONDITIONS

SYMBOL	PARAMETER	UNITS	MIN	TYP	MAX
V _{CC}	Supply Voltage	V	4.5	5.0	5.5

PIN DESCRIPTIONS

Pin No.	Symbol	Applied Voltage (V)	Pin Voltage (V)	Description	Internal Equivalent Circuit
1	Input	—	0.9	Signal input pin. An internal matching circuit, configured with resistors, enables 50 Ω connection over a wide bandwidth. A multi-feedback circuit is designed to cancel the deviations of h _{FE} and resistance. This pin must be coupled to the signal source with a blocking capacitor.	
4	Output	—	—	Signal output pin. Connect an inductor between this pin and V _{CC} to supply current to the internal output transistors.	
6	V _{CC}	4.5 to 5.5	—	Power supply pin. This pin should be externally equipped with a bypass capacitor to minimize ground impedance.	
2 3 5	GND	0	—	Ground pins. These pins should be connected to system ground with minimum inductance. Ground pattern on the board should be formed as wide as possible. All the ground pins must be connected together with wide ground pattern to minimize impedance difference.	

TYPICAL PERFORMANCE CURVES (T_A = 25°C)

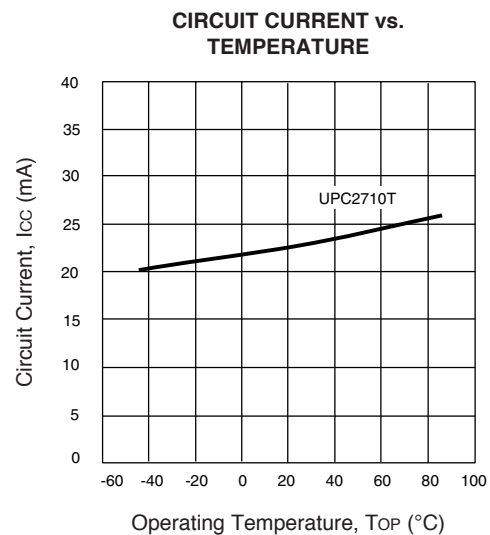
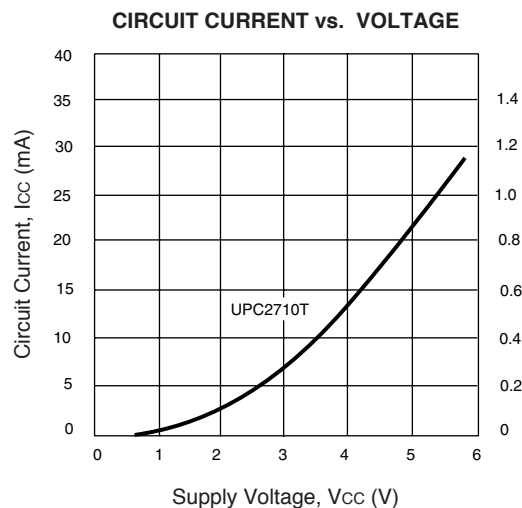

TYPICAL PERFORMANCE CURVES (TA = 25° C)

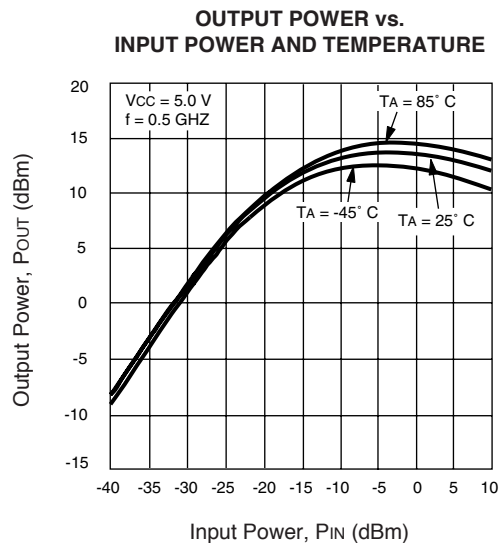
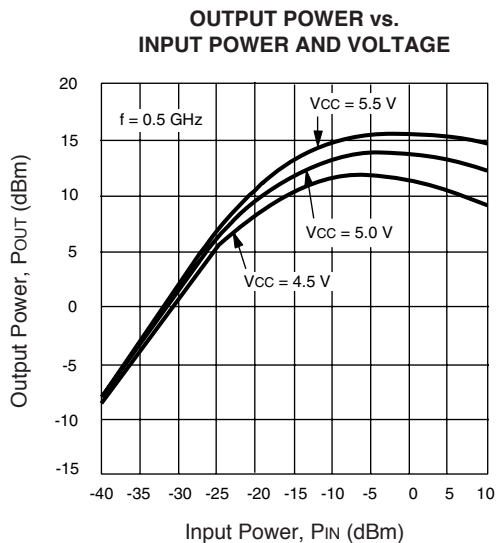
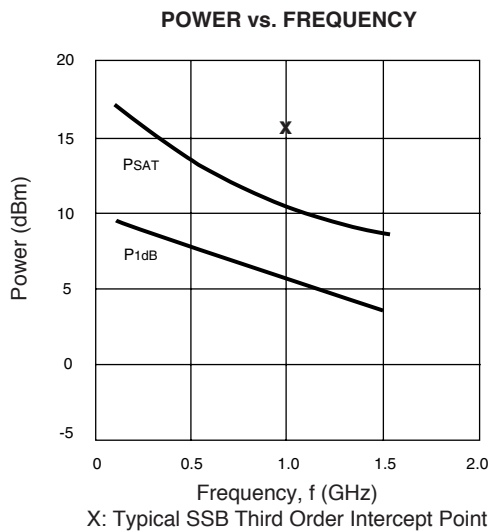
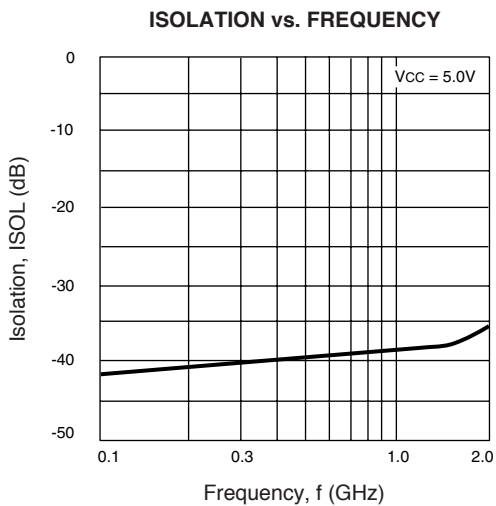
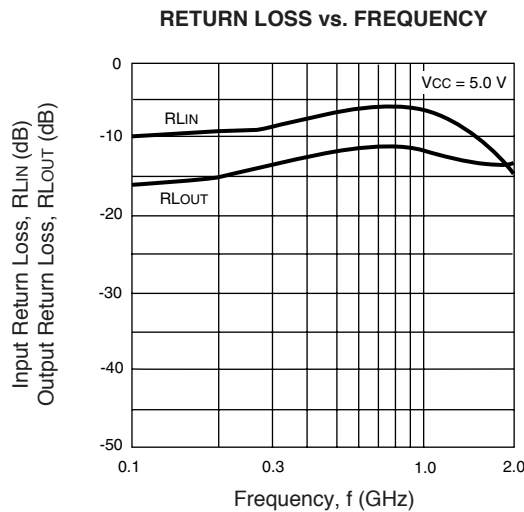
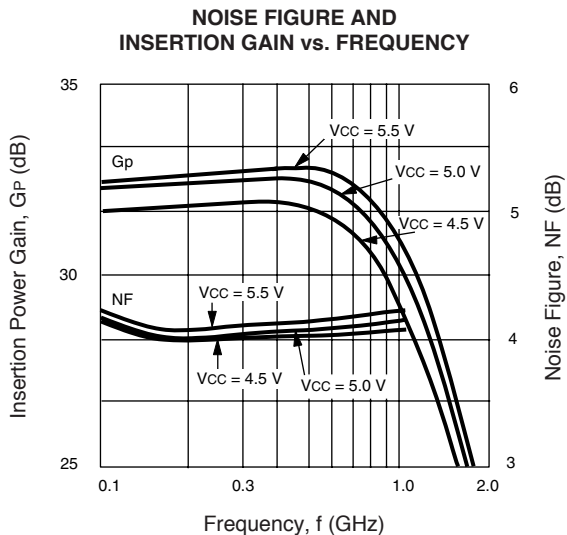

TYPICAL PERFORMANCE CURVES (T_A = 25°C)

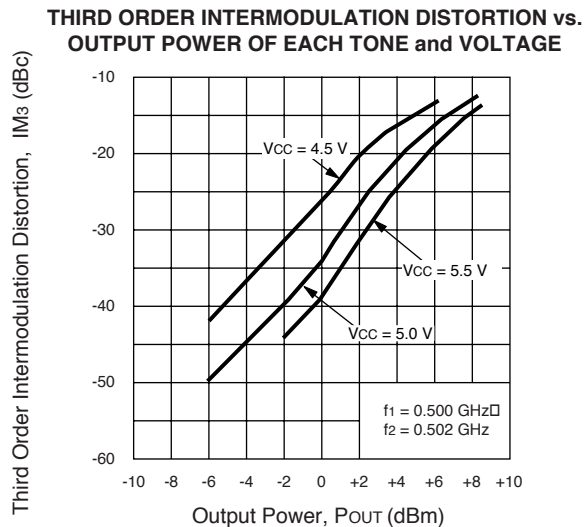
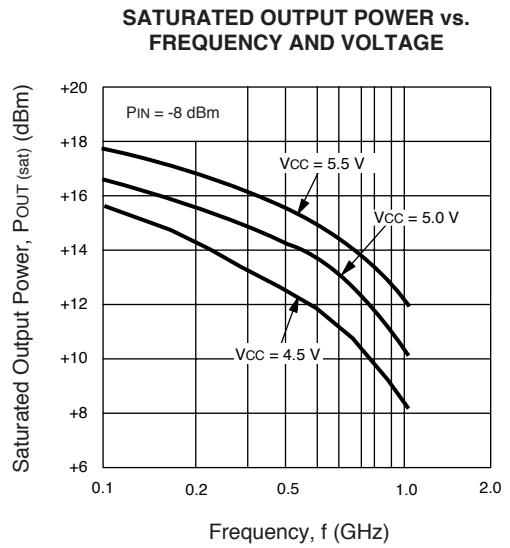
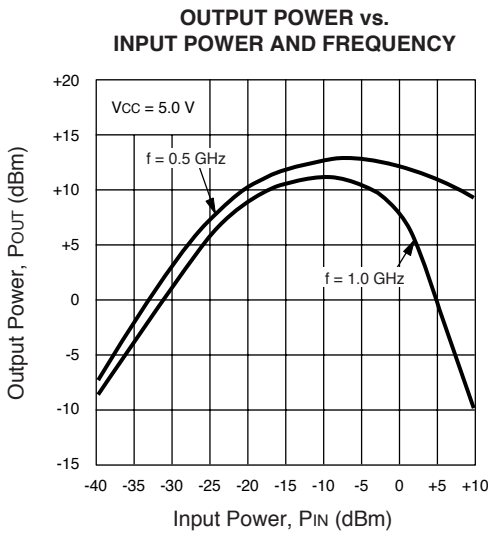
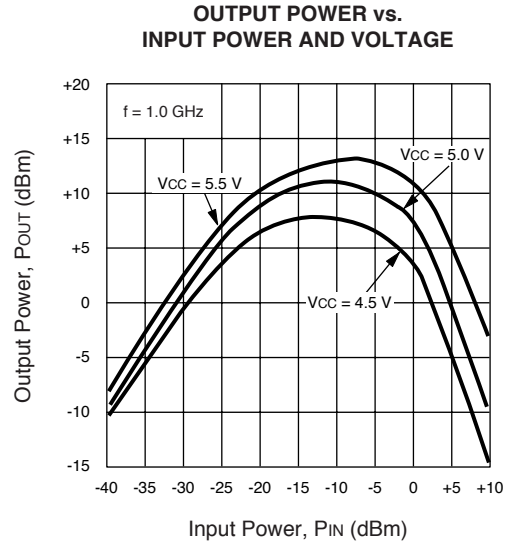
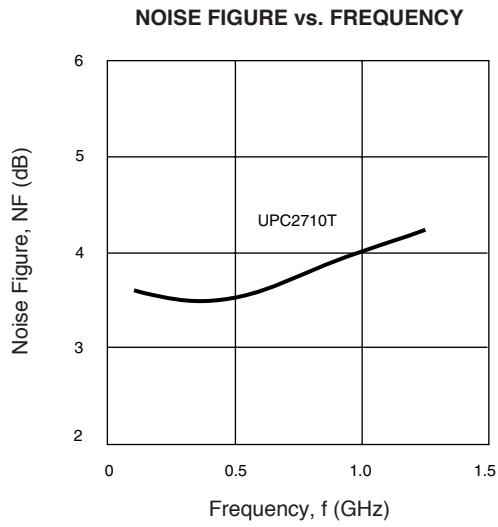

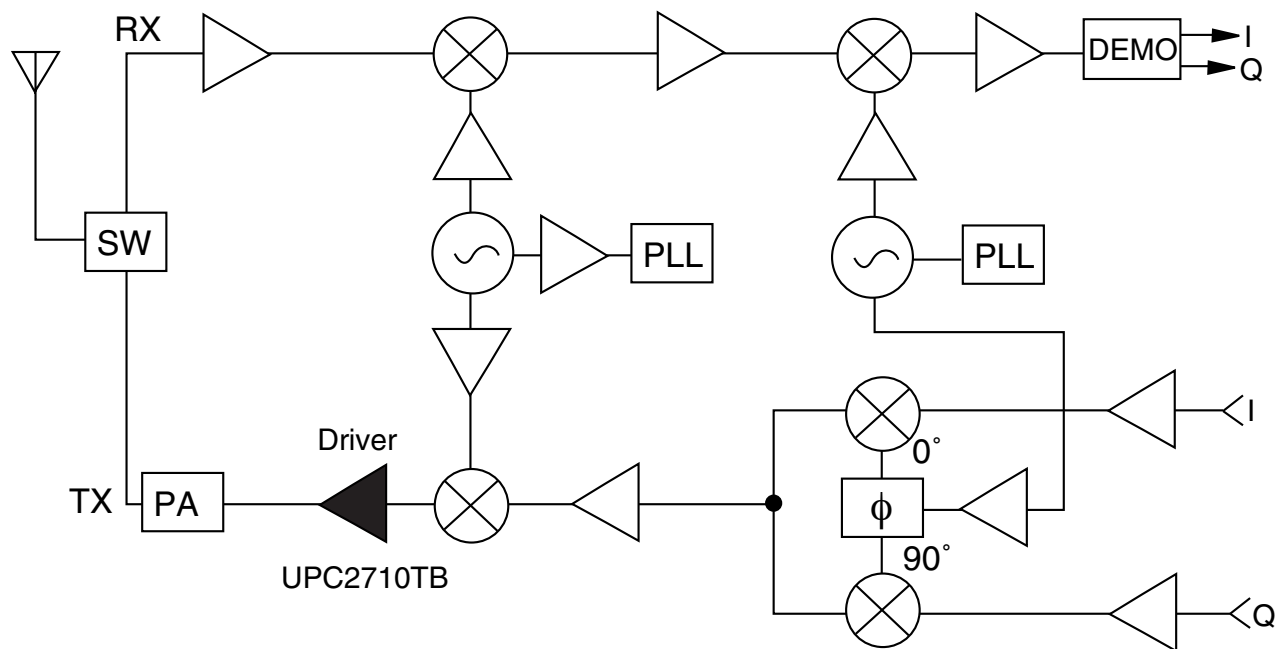
SYSTEM APPLICATION EXAMPLE**Example of 900 MHz Band Digital Cellular Telephone**

TYPICAL SCATTERING PARAMETERS (TA = 25°C)

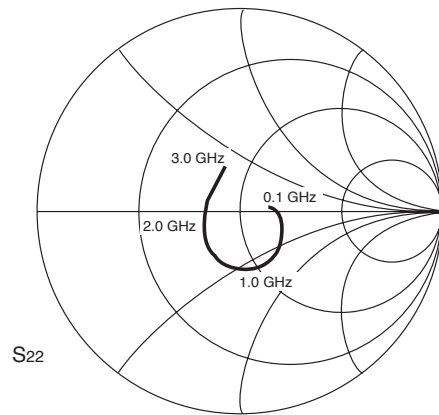
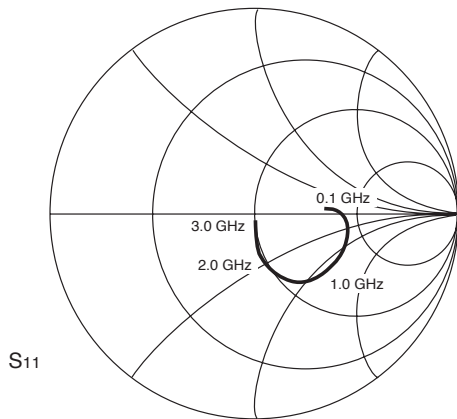

UPC2710TB

VCC = VOUT = 5 V, Icc = 22 mA

FREQUENCY	S11		S21		S12		S22		K
GHz	MAG	ANG	MAG	ANG	MAG	ANG	MAG	ANG	
0.1	0.306	2.5	43.072	-8.4	0.012	15.2	0.156	2.7	1.08
0.2	0.324	5.2	43.517	-17.1	0.010	10.7	0.164	2.1	1.17
0.3	0.356	5.3	44.432	-26.5	0.010	20.2	0.185	0.3	1.10
0.4	0.400	2.5	45.513	-36.9	0.012	26.9	0.225	-5.5	0.92
0.5	0.439	-3.3	45.679	-48.1	0.012	27.0	0.255	-15.4	0.85
0.6	0.469	-10.2	45.670	-59.7	0.013	31.3	0.283	-27.6	0.77
0.7	0.481	-17.9	44.793	-71.8	0.014	27.9	0.312	-54.9	0.74
0.8	0.488	-26.7	43.016	-84.3	0.014	34.9	0.301	-40.2	0.74
0.9	0.479	-34.5	40.519	-96.0	0.013	26.6	0.307	-92.2	0.85
1.0	0.465	-41.2	37.946	-107.3	0.016	30.8	0.311	-79.5	0.79
1.1	0.448	-49.3	35.122	-117.9	0.016	26.6	0.307	-92.2	0.85
1.2	0.417	-54.9	32.108	-128.0	0.015	39.5	0.282	-104.6	0.99
1.3	0.387	-61.2	29.221	-137.0	0.015	39.7	0.270	-115.5	1.12
1.4	0.350	-65.2	26.656	-145.8	0.015	50.2	0.248	-127.0	1.27
1.5	0.316	-70.8	23.895	-153.9	0.013	50.8	0.236	-136.2	1.56
1.6	0.292	-74.0	21.576	-161.6	0.016	56.6	0.215	-145.3	1.49
1.7	0.256	-76.9	19.567	-168.1	0.015	69.0	0.200	-155.2	1.71
1.8	0.245	-80.5	17.743	-174.4	0.018	61.7	0.196	-162.5	1.59
1.9	0.215	-82.9	16.040	179.6	0.017	70.0	0.180	-173.4	1.88
2.0	0.201	-85.6	14.717	173.5	0.021	71.2	0.175	-178.1	1.71
2.1	0.177	-84.4	13.475	168.8	0.020	83.0	0.166	172.0	1.94
2.2	0.161	-88.8	12.327	163.1	0.021	76.7	0.171	167.7	1.99
2.3	0.145	-88.7	11.154	158.7	0.022	87.9	0.159	159.7	2.08
2.4	0.124	-90.3	10.262	154.4	0.023	81.4	0.164	154.0	2.15
2.5	0.113	-89.8	9.490	150.4	0.025	91.9	0.158	147.0	2.19
2.6	0.107	-91.9	8.793	146.4	0.028	88.7	0.166	141.8	2.06
2.7	0.091	-92.2	8.149	142.4	0.030	93.4	0.175	135.7	2.13
2.8	0.081	-94.9	7.652	138.9	0.031	92.1	0.183	131.6	2.13
2.9	0.067	-97.4	7.134	135.1	0.031	93.0	0.191	123.4	2.26
3.0	0.055	-103.8	6.726	131.5	0.039	88.3	0.200	118.9	1.97
3.1	0.039	-95.6	6.295	128.4	0.039	89.6	0.203	111.5	2.08

OUTLINE DIMENSIONS (Units in mm)

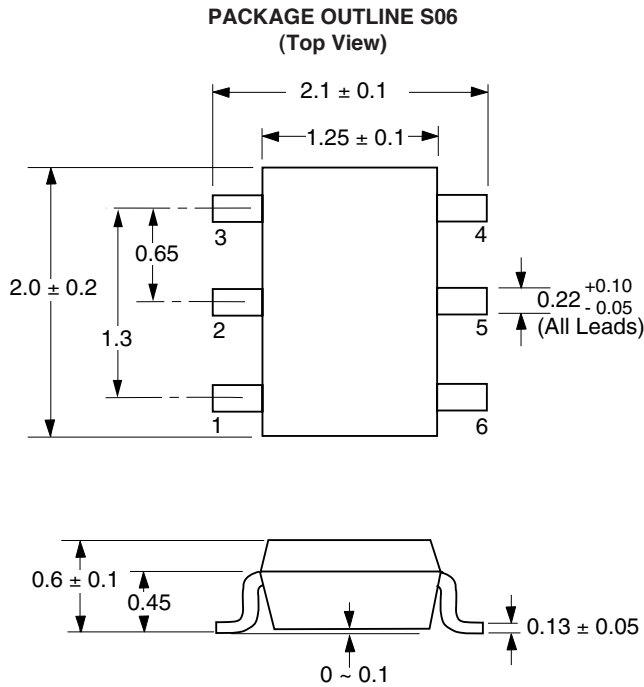

PIN CONNECTIONS

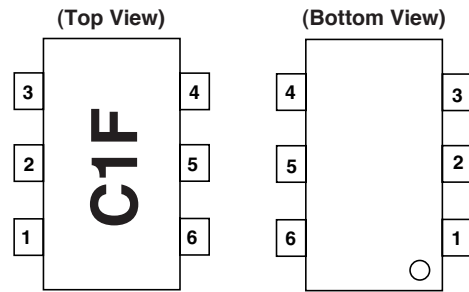

- 1. INPUT
- 2. GND
- 3. GND
- 4. OUTPUT
- 5. GND
- 6. Vcc

TEST CIRCUIT

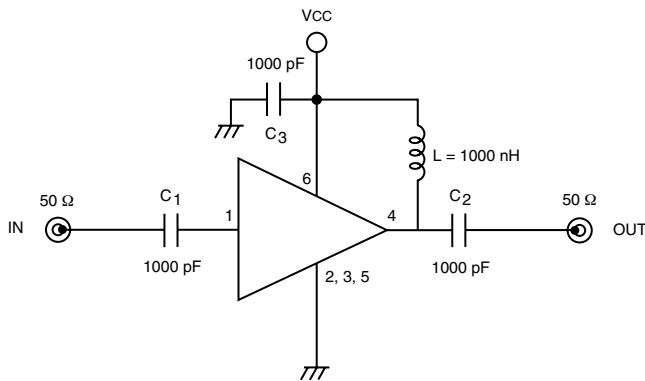

EQUIVALENT CIRCUIT

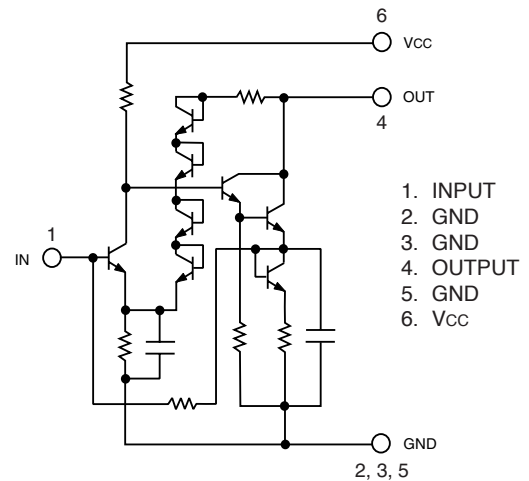

ORDERING INFORMATION

PART NUMBER	MARKING	QTY
UPC2710TB-E3-A	C1F	3K/Reel

Note:
Embossed Tape, 8 mm wide. Pins 1, 2 and 3 face perforated side of tape.

Life Support Applications

These NEC products are not intended for use in life support devices, appliances, or systems where the malfunction of these products can reasonably be expected to result in personal injury. The customers of CEL using or selling these products for use in such applications do so at their own risk and agree to fully indemnify CEL for all damages resulting from such improper use or sale.

EXCLUSIVE NORTH AMERICAN AGENT FOR **NEC** RF, MICROWAVE & OPTOELECTRONIC SEMICONDUCTORS

CEL CALIFORNIA EASTERN LABORATORIES • Headquarters • 4590 Patrick Henry Drive • Santa Clara, CA 95054-1817 • (408) 988-3500 • Telex 34-6393 • FAX (408) 988-0279
24-Hour Fax-On-Demand: 800-390-3232 (U.S. and Canada only) • Internet: <http://WWW.CEL.COM>

Subject: Compliance with EU Directives

CEL certifies, to its knowledge, that semiconductor and laser products detailed below are compliant with the requirements of European Union (EU) Directive 2002/95/EC Restriction on Use of Hazardous Substances in electrical and electronic equipment (RoHS) and the requirements of EU Directive 2003/11/EC Restriction on Penta and Octa BDE.

CEL Pb-free products have the same base part number with a suffix added. The suffix –A indicates that the device is Pb-free. The –AZ suffix is used to designate devices containing Pb which are exempted from the requirement of RoHS directive (*). In all cases the devices have Pb-free terminals. All devices with these suffixes meet the requirements of the RoHS directive.

This status is based on CEL’s understanding of the EU Directives and knowledge of the materials that go into its products as of the date of disclosure of this information.

Restricted Substance per RoHS	Concentration Limit per RoHS (values are not yet fixed)	Concentration contained in CEL devices	
		-A	-AZ
Lead (Pb)	< 1000 PPM	Not Detected	(*)
Mercury	< 1000 PPM	Not Detected	
Cadmium	< 100 PPM	Not Detected	
Hexavalent Chromium	< 1000 PPM	Not Detected	
PBB	< 1000 PPM	Not Detected	
PBDE	< 1000 PPM	Not Detected	

If you should have any additional questions regarding our devices and compliance to environmental standards, please do not hesitate to contact your local representative.

Important Information and Disclaimer: Information provided by CEL on its website or in other communications concerning the substance content of its products represents knowledge and belief as of the date that it is provided. CEL bases its knowledge and belief on information provided by third parties and makes no representation or warranty as to the accuracy of such information. Efforts are underway to better integrate information from third parties. CEL has taken and continues to take reasonable steps to provide representative and accurate information but may not have conducted destructive testing or chemical analysis on incoming materials and chemicals. CEL and CEL suppliers consider certain information to be proprietary, and thus CAS numbers and other limited information may not be available for release.

In no event shall CEL’s liability arising out of such information exceed the total purchase price of the CEL part(s) at issue sold by CEL to customer on an annual basis.

See CEL Terms and Conditions for additional clarification of warranties and liability.